

# GMV Super Star

## Part List

---



# Table of Contents

<b>Part List</b>	<b>25</b>
Magazine.....	28
Target Retainer .....	30
Throwing Table.....	31
Main Frame.....	32
Turntable .....	33
Base .....	34
Elevator .....	35
Throwing Arm .....	36
Motor .....	38
Spring .....	41
Electric Box .....	42
Miscellaneous.....	44
Safety Release .....	45

**PARTS** MAGAZINE



GMV 10 Assembly  
 GMV 11 Assembly  
 GMV 12 Assembly  
 GMV 13 Assembly



GMV 14



GMV 10



GMV 11



GMV 12



GMV 13



GMV



GMV

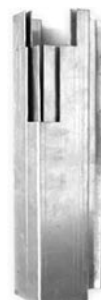

GMV

<b>PARTS #</b>	<b>PARTS NAME</b>	<b>DESCRIPTION</b>
GMV 10 Assembly	Complete magazine	250 Targets
GMV 11 Assembly	Complete magazine	400 Targets
GMV 12 Assembly	Complete magazine	700 Targets
GMV 13 Assembly	Complete magazine	900 Targets
GMV 10	Magazine structure 1 pc	250 Targets
GMV 11	Magazine structure 1 pc	400 Targets
GMV 12	Magazine structure 1 pc	700 Targets
GMV 13	Magazine structure 1 pc	900 Targets
	Self tapping bolt	M6SF-TT M5
GMV 14	Magazine base	
	Bolt	MC6S M8x20
	Washer	8,4x16
GMV	Elevator	
GMV	Sleeve midi	
GMV	Sleeve mini	



GMV 15



GMV 18



GMV 23



GMV 23A



GMV 19

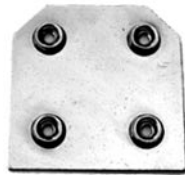

GMV 19A

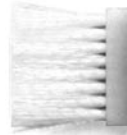

GMV 24



GMV 24A



GMV 24B

PARTS #	PARTS NAME	DESCRIPTION
GMV 15	Magazine center	
GMV 18	Lock ring magazine center	SGA 30
GMV 19	Magazine shaft bolt	MC6S M8x35
	washer	8,4x16
GMV 19A	Magazine plate	
GMV 23	Guide finger (target)	
GMV 23A	Guide finger (target) washer guide finger	
	nut	M6
	nut	M8
	hex bolt	MC6S M6x35
	screw	
GMV 24	Brush	
GMV 24A	Complete brush	
GMV 24B	Brush bracket	

**PARTS TARGET RETAINER**

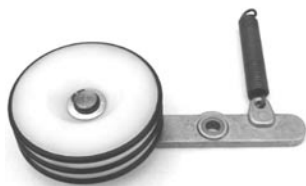

GMV 26 Assembly



GMV 27



GMV 25



GMV 26



GMV 29



GMV 30



GMV 31

<b>PARTS #</b>	<b>PARTS NAME</b>	<b>DESCRIPTION</b>
GMV 26 Assembly	Complete target retainer	
GMV 25	Spring	2.5x16x100
GMV 26	Pivot arm target ret. wheel	
GMV 27	Pivot arm bushing	10.5x10
GMV 28	Pivot arm bushing screw	16x10 MC6S M6x35 BRB 16x28
		85x5
		SGA 15

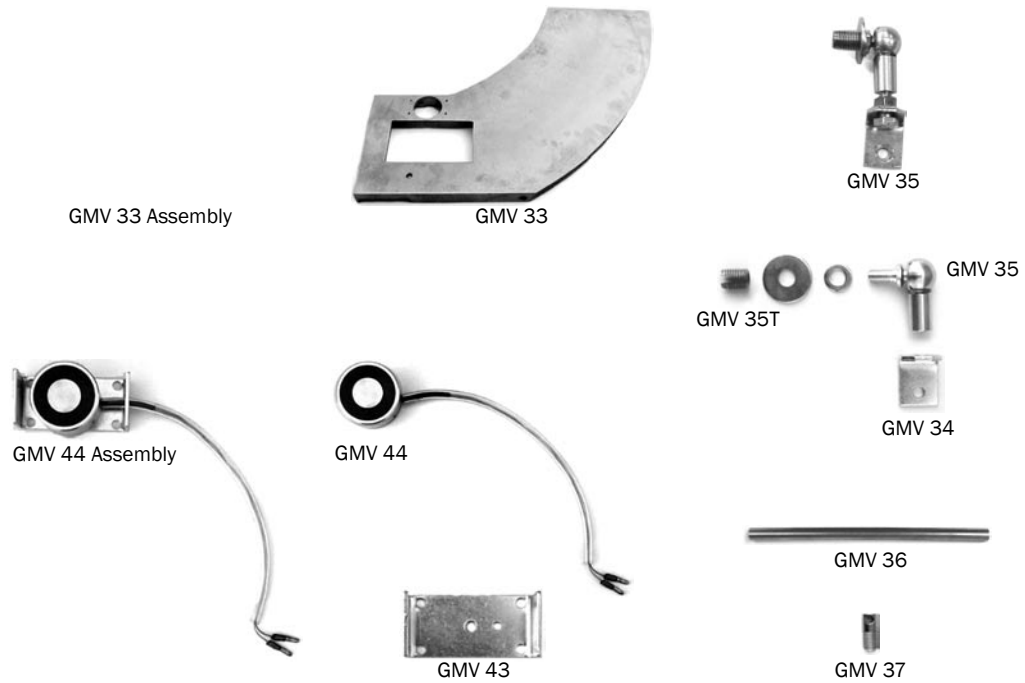

<b>PARTS #</b>	<b>PARTS NAME</b>	<b>DESCRIPTION</b>
GMV 33 Assembly	Complete throwing table	200 & 400 Series
GMV 33	Throwing table	200 & 400 Series
GMV 35 Assembly	Complete link head assembly	
GMV 34	Link head bracket	
GMV 35	Link head	M8
GMV 35T	T&S Threaded insert, link head	GDE M8
GMV 36	Target guide rail	
GMV 37	Target guide rail bracket	200 & 400 Series
GMV 44 Assembly	Complete electro magnet	
GMV 43	Electro magnet bracket	30x50

**PARTS MAIN FRAME**

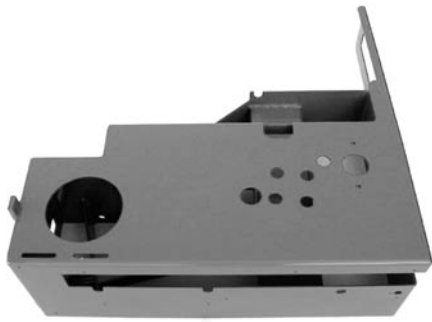

GMV 32

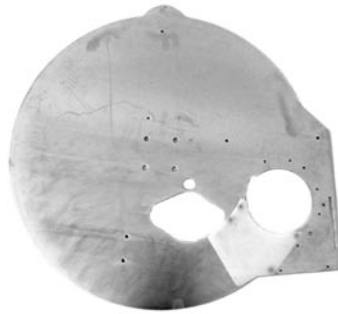

GMV 20



GMV 22A



GMV 21



GMV 22



GMV 275



GMV 87

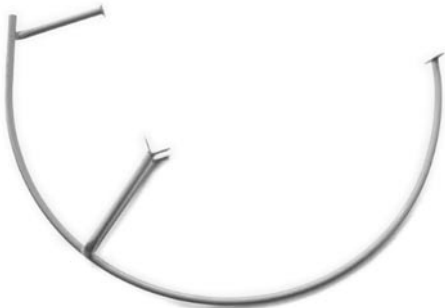

GMV 168



GMV 169

---

<b>PARTS #</b>	<b>PARTS NAME</b>	<b>DESCRIPTION</b>
GMV 16	Bushing	
GMV 20	Magazine plate	
GMV 21	Leaf spring bracket	
GMV 22	Leaf spring	
GMV 22A	Sliding plate Bolt	
GMV 32	Main frame	
GMV 87	Belt cover	
GMV 168	Safety guard	
GMV 169	Safety guard	





PARTS #	PARTS NAME	DESCRIPTION
GMV 60		CUFF 205
GMV 117		200 Series
GMV 117A		
GMV 118		
GMV 119		30208GPZ
GMV 120		110x80x8
GMV 121		110x40x5
GMV 122		KM 12
GMV 124		GE12/c
GMV 124A		
GMV 134 Assembly		
GMV 134		
GMV 139		200 Series
GMV 140		A 36
GMV 141		
GMV 142		75/1

**PARTS** BASE



GMV 126



GMV 123



GMV 128A

---

<b>PARTS #</b>	<b>PARTS NAME</b>	<b>DESCRIPTION</b>
GMV 123		400 Series
GMV 126		400 Series
GMV 128A		Skeet

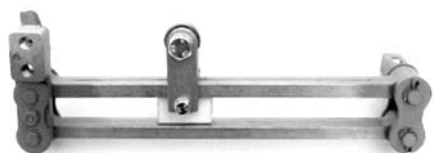

GMV 50 Assembly



GMV 50



GMV 51



GMV 49



GMV 49A



GMV 48



GMV 56



GMV 57



GMV 25

GMV 55A

GMV 55



GMV 55B

GMV 53

GMV 54

GMV 52

PARTS #	PARTS NAME	DESCRIPTION
GMV 48	Elevator	
GMV 50 Assembly	Complete	
GMV 49	Elevator link front	
GMV 49A	Elevator link rear	
GMV 50	Upper elevator arm	
GMV 51	Lower elevator arm	
GMV 52	Inner bracket	
GMV 53	Outer bracket	
GMV 54	Plastix spacer	21x10x35
GMV 55	Bearing	6000-2RS
GMV 55A	Bolt M6S	M6x30
GMV 55B	Bolt M6S	
GMV 56	Elevator bracket, rear	
GMV 57	Elevator spacer	
GMV 25	Elevator spring	

**PARTS** THROWING ARM



**PARTS #**

**PARTS NAME**

**DESCRIPTION**

GMV 58	Timing gear	200 - 500 Series
GMV 65 Assembly	Complete	
GMV 63	Belt pulley	150/2
GMV 64	Hex bolt	MC6S M8x20
GMV 65	Cam shaft	
	Cam	
	Screw	MPH M6x16
GMV 62	Timing gear shaft	
GMV 62A	Bearing	
GMV 66	Throwing arm holder	
	Allen bolt hardened	M8x25
GMV 68	Throwing arm	
	Washer throwing arm	
	Bearing main belt pulley	CUFF 205

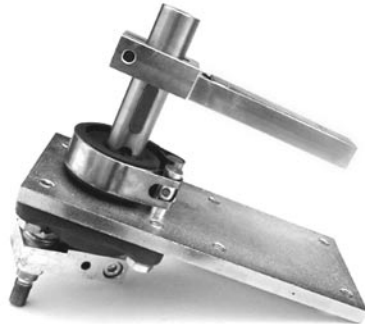

GMV 74 Assembly



GMV 71



GMV 61



GMV 77 Assembly



GMV 60



GMV 69



GMV 70 70A 70B

<b>PARTS #</b>	<b>PARTS NAME</b>	<b>DESCRIPTION</b>
GMV 60	Main bearing	CUFF 205
GMV 61	Woodruff key	4x16
GMV 69	Assembly plate, main shaft	
GMV 70	One way bearing	AS 425
GMV 70A	One way bearing dust cover	
GMV 70B	One way bearing lock ring	
GMV 71	Break shoe	B025x05,5
GMV 74 Assembly		
GMV 77 Assembly		

**PARTS MOTOR**

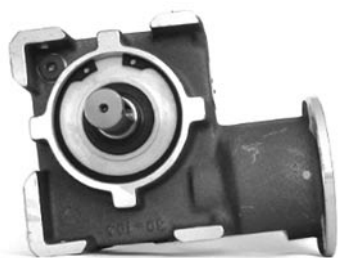

GMV 94, 95, 96



GMV 103



GMV 107, 108, 109



GMV 104



GMV 99, 100



GMV 105



GMV 107A, 108A



GMV 101,102



GMV 106



GMV 107B, 107D



GMV 97



GMV 93

PARTS #	PARTS NAME	DESCRIPTION
GMV 93	Gearbox bracket	
GMV 94	Gearbox 81:1	Main
GMV 95	Gearbox 64:1	Earlier Oscillating
GMV 96	Gearbox 41:1	Earlier main
GMV 97	Lid	For clutch adjustment
GMV 99	Belt pulley	118/2 (200-400Series)
GMV 100	Belpulley	95/1 (GMV285T)
GMV 101	Belt for al w/o GMV285T	A56
GMV 102	Belt GMV285T	
GMV 103	Electromagnetic rotor	24V
GMV 104	Electromagnetic clutch	
GMV 105	Nylon washer clutch	
GMV 106	O-ring, clutch	69 2x5.7
GMV 107	Motor	1800 RPM
GMV 107A	Capacitor	1800 RPM
GMV 107B	Autofuse	15 A
GMV 107D	Autofuse	8 A
GMV 108	Motor	3600 RPM
GMV 108A	Capacitor	3600 RPM
GMV 109	Motor	1200 RPM (side motion 1200 R)

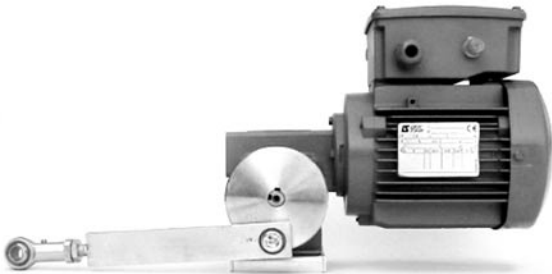

GMV 132 Assembly



GMV 132



GMV 130



GMV 131 Assembly



GMV 132A



GMV 124A



GMV 131



GMV 124



GMV 129T

PARTS #	PARTS NAME	DESCRIPTION
GMV 124	Bearing, horisontal mvmt rod	GE 12/c
GMV 124A		
GMV 129T	Base vertical motor	GMV296T
GMV 130	Crank pulley	Vertical (GMV296T)
GMV 131	Connecting rod Bult Washer	GMV296T M8 M8 M8
GMV 131 Assembly		
GMV 132 Assembly		
GMV 132		GMV296T

**PARTS MOTOR**



GMV 211



GMV 210



GMV 205



GMV 206



GMV 212



GMV 214

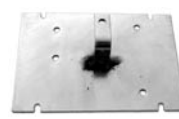

GMV 207



GMV 208 GMV 209



GMV 218



GMV 216



GMV 99

---

<b>PARTS #</b>	<b>PARTS NAME</b>	<b>DESCRIPTION</b>
GMV 99	Belt pulley	
GMV 205	Key	
GMV 206	Main on off switch	
GMV 207	Electric mounting plate	
GMV 208	Battery clamp	
GMV 209	Battery clamp	
GMV 210	Gear box	
GMV 211	Motor	
GMV 212	Gear	
GMV 214	Fuse	
GMV 216	Relay	
GMV 217	Connecing rod	
GMV 218	Fuse holder	





GMV 86 Assembly



GMV 85



GMV 84



GMV 86



GMV 78



GMV 81, 83



GMV 79



GMV 80



GMV 88



GMV 89



GMV 90



GMV 91



GMV 92



GMV 88A

PARTS #	PARTS NAME	DESCRIPTION
GMV 78	Threaded rod main spring	M16x950
GMV 79	Main spring, end	
	Washer	M12 D113
	Nylock nut	M12
	Washer	C13 M12
GMV 80	Bearing spring end	6002-2RS
GMV 81	Spring	Yellow
GMV 83	Spring	Black
GMV 84	Washer, spring eyelet	
GMV 85	Eyelet	
GMV 86 Assembly	Complete spring connection	
GMV 86	Main spring connect. rear	
GMV 88	Spring lever bracket	
GMV 88A	Spring tension adjustment rod	
GMV 89	Spring spacer, extra thin	
GMV 90	Spring spacer, small	
GMV 91	Spring spacer, medium	
GMV 92	Spring spacer, large	

**PARTS ELECTRIC BOX**



GMV 137 Assembly



GMV 145A, 145B Assembly



GMV 144



GMV 145



GMV 156



GMV 157



GMV 146



GMV 147



GMV 155A



GMV 162



GMV 161



GMV 161B



GMV 148



GMV 154



GMV 162A



GMV 161A



GMV 161C

PARTS #	PARTS NAME	DESCRIPTION
GMV 137 Assembly	Complete box	
GMV 137	Connector box	200 Series
GMV 138	Cover	200 Series
GMV 144	Interrupter	
GMV 145	Bridge rectifier	Older model
GMV 145A Assembly	Complete bridge transformer	230 V/24 V, Europa
GMV 145B Assembly	Complete bridge transformer	115 V/24 V
GMV 146	Relay timing for safety release	200 Series
GMV 147	Safety release relay	200 Series
GMV 148	Main switch	200 Series
GMV 154	Wire connector	
GMV 155A	Skin top	
GMV 156	Push button assembly	Skeet
GMV 157	Push button assembly	Trap
GMV 161	Pull cord end	Skeet
GMV 161A	Pull cord end	Skeet, Europa
GMV 161B	Cord end	115V
GMV 161C	Cord end	230V, Europa
GMV 162	Pull cord outlet	Skeet
GMV 162A		Skeet, Europa

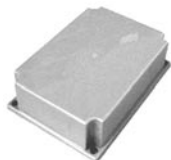

GMV 113



GMV 114

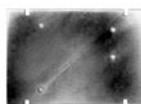

GMV 114A



GMV 114B



GMV 143  
GMV 143A



GMV 152



GMV 47



GMV 47A



GMV 150, 151



GMV 153



GMV 45



GMV 45A



GMV 155



GMV 155A



GMV 310

<b>PARTS #</b>	<b>PARTS NAME</b>	<b>DESCRIPTION</b>
GMV 45	Microswitch bracket	
GMV 45A	Threaded bracket	
GMV 47	Microswitch	
GMV 47A	Microswitch housing	
	Screw	MCS M3x30
	Nut	M3
GMV 113	Main electric box cover	
GMV 114	Main connector box	
GMV 114A	Assembly plate	Main electric box
GMV 114B	Plastic screws	Main electric box
GMV 143	Transformer	115V/24V
GMV 143A	Transformer	230V/24V, Europa
GMV 150	Relay	24V
GMV 151	Relay	
GMV 152	Relay socket	
GMV 153	Circuit board	
GMV 155	Rubberplugs	
GMV 155A	Skin top	
GMV 310	Counter	

**PARTS MISCELLANEOUS**

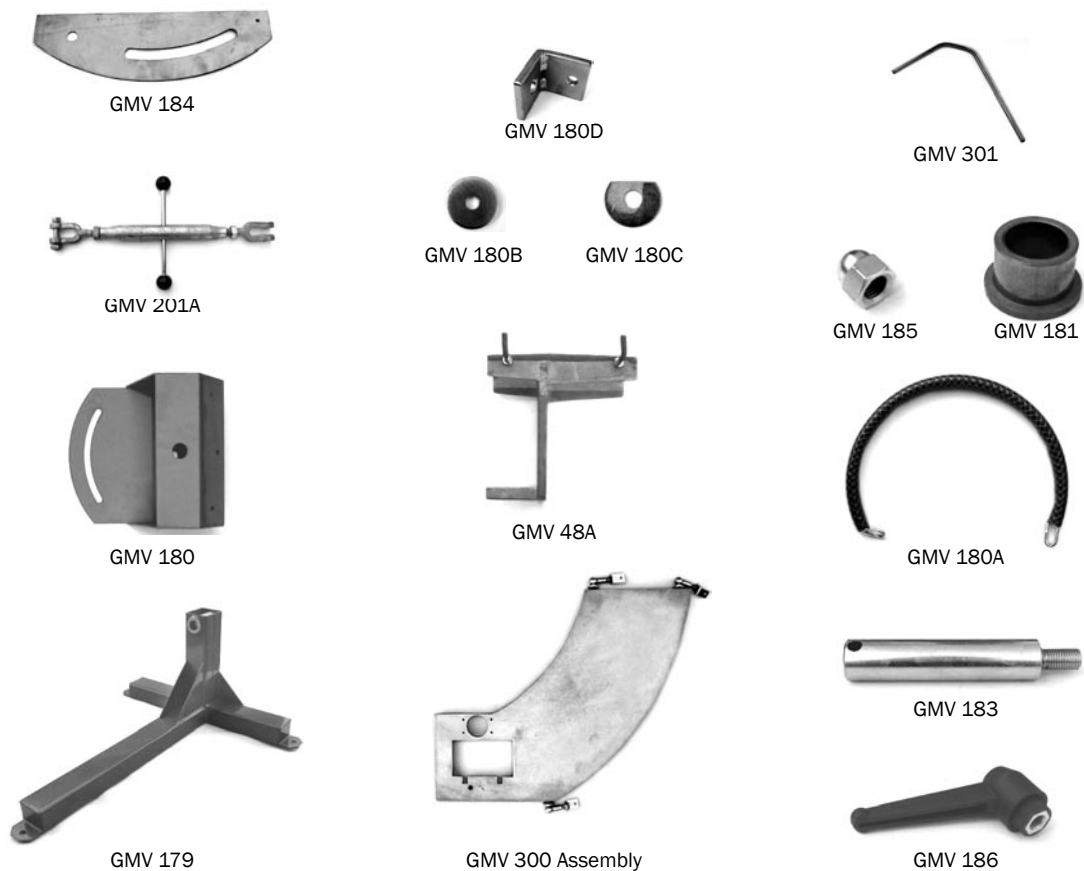

<b>PARTS #</b>	<b>PARTS NAME</b>	<b>DESCRIPTION</b>
GMV 48A	Elevator	
GMV 179	Main frame	
GMV 180	Swivel base	
GMV 180A	Safety chain	
GMV 180B	Bushing	
GMV 180C	Bushing	
GMV 180D	Bracket	
GMV 181	Bushing	
GMV 183	Shaft	
GMV 184	Adjustment plate	
GMV 185	Nut	
GMV 186	Lock lever	
GMV 201A	Turnbuckle	
GMV 300 Assembly	Complete table	
GMV 301	Target guide rail	



GMV 149 Assembly



GMV 163 Assembly



GMV 164



GMV 164A



GMV 149A, 149B

---

<b>PARTS #</b>	<b>PARTS NAME</b>	<b>DESCRIPTION</b>
GMV 149 Assembly	Complete	
GMV 149	Safety release box	
GMV 149A	Block	
GMV 149B	Block	
GMV 163 Assembly	Complete	
GMV 163	Safety release box	
GMV 164	Safety release switch	
GMV 164A	Safety release push button	

